

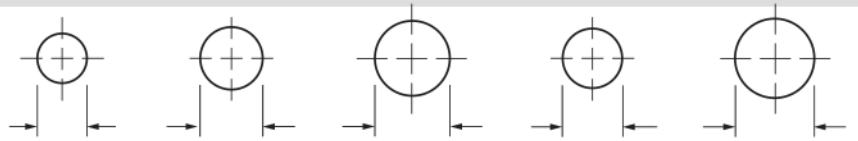







125mm Rotacasters

Bores (nominal)



| Roller Type | Load Capacity Lateral / Dynamic | Bush/Bearing | ID Ø8 | Ø10 | Ø12 | Ø9.52 | Ø12.7 |
|--|---|-----------------------|----------------|----------------|----------------|----------------|----------------|
|  85A Polyurethane Roller on Nylon bushing |  R2 68/115 Kg | R2-1258-85 No Bearing | | | | | |
| | | Nylon | --- | --- | R2-1258-85/N12 | --- | R2-1258-85/N13 |
| | | Shielded | --- | R2-1258-85/Z10 | --- | R2-1258-85/Z09 | --- |
| | | Sealed | R2-1258-85/S08 | R2-1258-85/S10 | R2-1258-85/S12 | --- | R2-1258-85/S13 |
|  95A Polyurethane Roller on Nylon bushing |  R2 68/125 Kg | R2-1258-95 No Bearing | | | | | |
| | | Nylon | --- | --- | R2-1258-95/N12 | --- | R2-1258-95/N13 |
| | | Shielded | --- | R2-1258-95/Z10 | --- | R2-1258-95/Z09 | --- |
| | | Sealed | R2-1258-95/S08 | R2-1258-95/S10 | R2-1258-95/S12 | --- | R2-1258-95/S13 |
|  95A Polyurethane Roller on Nylon bushing |  R3 80/160 Kg | R3-1258-95 No Bearing | | | | | |
| | | Nylon | --- | --- | R3-1258-95/N12 | --- | R3-1258-95/N13 |
| | | Shielded | --- | R3-1258-95/Z10 | --- | R3-1258-95/Z09 | --- |
| | | Sealed | --- | R3-1258-95/S10 | R3-1258-95/S12 | --- | R3-1258-95/S13 |

Wheel Dimensions (in mm)

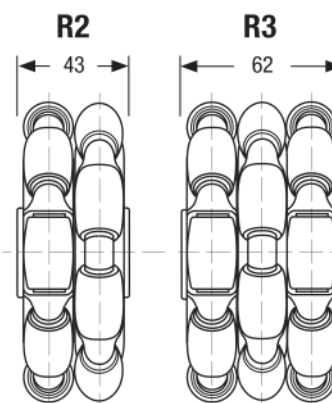
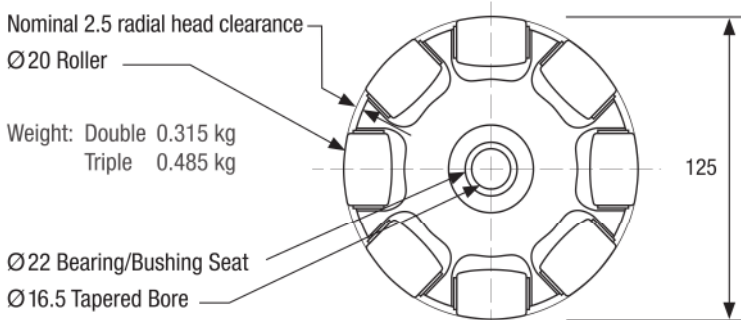

Conversion

| Metric | Imperial |
|----------|----------|
| 3.18 mm | 1/8" |
| 6.35 mm | 1/4" |
| 8.00 mm | 5/16" |
| 9.52 mm | 3/8" |
| 11.10 mm | 7/16" |
| 12.70 mm | 1/2" |
| 15.88mm | 5/8" |
| 25.40 mm | 1" |
| 1 kg | 2.2 lb |

Lateral Load Capacity refers to the maximum load capacity of each wheel to travel directly sideways without radial head contact. ■ The **Dynamic Load Capacity** (while in motion) ranges between the maximum **Static Load Capacity** and the **Lateral Load Capacity** and varies proportionally to speed of the wheel travelling in its primary direction. ★ Single wheels are available upon request. ■ 12mm and 1/2" bush may require hub fit.



Distributor Rotacaster 1300 768 222

rotacaster.com.au

rotacaster
the ultimate in manoeuvrability